

GEONAV AP 201 AUTOPILOT

**INSTRUCTION MANUAL
FOR
USE & INSTALLATION**

GEONAV

NAVIONICS S.p.A.

Via Vespucci, 289 - 55049 Viareggio (LU) - ITALY
tel. +39 0584 961696 fax. +39 0584 961309
www.geonav.it info@geonav.it

Contents

FOREWORD	5
WARRANTY	6
THE AP 201 AUTOPILOT	7
DECLARATION OF COMPLIANCE TO THE EEC 89/336 DIRECTIVE	8
USER'S MANUAL	9
IMPORTANT WARNINGS.....	10
PRELIMINARY OPERATIONS AND START OF NAVIGATION.	11
<i>Starting</i>	11
<i>Display and keyboard illumination</i>	11
<i>Setting of the operating parameters</i>	11
<i>Setting of the route and automatic navigation</i>	12
SIGNALLED ALARMS	14
INSTALLATION MANUAL.....	15
INSTALLATION PROCEDURES.....	16
<i>Control Unit</i>	16
<i>Control Unit (as OPTIONAL remote control)</i>	16
<i>Processor Box AP</i>	17
<i>Fluxgate Compass FGX90/3, FGX90N</i>	17
<i>Rudder Angle Transducer FB30, FB31</i>	17
<i>Electrohydraulic Unit</i>	18
PRELIMINARY TEST.....	19
<i>Rudder Feedback FB30, FB31</i>	19
<i>Rudder Indicator AR32, AR33, AR34</i>	19
<i>Fluxgate Compass FGX90/3, FGX90N</i>	19
<i>Electrohydraulic Unit</i>	19
<i>GPS and/or Chart-Plotter</i>	19
<i>Wind Direction Sensor</i>	20
<i>Automatic compensation of the compass FGX90/3, FGX90N</i>	20
SOFTWARE INSTALLATION PROCEDURE	21
TECHNICAL SPECIFICATION	24

FOREWORD

Thank you for purchasing a GEONAV product and congratulations for your excellent choice.

You have now become the owner of a powerful and versatile electronic instrument which will make your moments of relax or work, at sea, more pleasant and secure.

You will be pleasantly surprised when you realize how easy and logical this system is to use, though technologically sophisticated.

No particular technical or nautical know-how is required for its correct use, nevertheless reading this manual with some attention will allow you to quickly learn and become confident in using it at it's best.

WARRANTY

The company **Navionics S.p.A.**, located in Viareggio - via Vespucci, 289, will guarantee the following:

1. **Navionics** products are guaranteed free from faults concerning materials and production. Therefore, any product showing a malfunction deriving from faulty manufacture or defective materials will be promptly replaced.
2. Warranty is limited to possible faults found within the first 24 months of purchase and installation.
3. Repair under guarantee will be carried out, free of charge, on faulty products which will be directly sent to **Navionics**. Any shipping, customs, packing and insurance costs are to Purchaser's account.
4. Warranty does not cover damage or malfunctioning deriving from improper use, installation or manipulation as well as deterioration due to normal use.
5. **Navionics** will not accept responsibilities on its products other than those mentioned above. It is also understood that Navicontrol will in no case be considered responsible for any kind of direct or indirect damage that may occur to people, animals or things due to the use of its products.
6. Any repair carried out by personnel unauthorized by **Navionics** will determine the immediate cancellation of warranty cover.
7. The use of **Navionics** products or services implies the complete acceptance of the present sale-conditions on behalf of the purchaser and of the user.

THE AP 201 AUTOPILOT

The AP 201 autopilot belongs to the latest generation in marine equipment where advanced research, sophisticated electronic technology and special care in quality standard, blend together so as to ensure a highly efficient, reliable, versatile and extendible product at a competitive cost.

It is however important to bear in mind the autopilot is made for seafaring and, due to rudder physical and mechanical limits, therefore cannot counteract a sharp variation of bow (such a sudden wave that may hit the vessel), but can only dampen the effect.

Steering parameters which vary within a wide range, make the autopilot easily suitable to all kind of vessel.

The main processing unit (framed in the Processor Box) brings the necessary corrections to the position of the rudder automatically, in order to guaranteeing the best maintenance of course.

The precision of routing is granted by a provided magnetic compass and can be integrated with external instruments (such a gyrocompass, turn rate sensor, GPS).

The control unit is provided with a large backlite LCD, easy-to-read in any light conditions (even at night).

In greater crafts provided with upper decks, it is possible to control the system thanks to the remote stations installed in different areas of the vessel.

Having purchased the AP 201 autopilot, you have acquired an autopilot which will prove itself an extremely helpful instrument for travelling.

Declaration of compliance to the EEC 89/336 directive

The building Company: Navicontrol s.r.l.
Address: Via dei Comparini, 39/24. 55049 Viareggio (LU) - ITALY

**DECLARES THAT THE FOLLOWING PRODUCTS AND ACCESSORIES ARE IN
COMPLIANCE WITH THE EEC 89/336 DIRECTIVE.**

Products:

AUTOPILOT AP801
AUTOPILOT AP401
AUTOPILOT AP201

Accessories:

PORTABLE REMOTE CONTROL RS32
REMOTE CONTROL RC34, RS34
REMOTE CONTROL ART35
RUDDER ANGLE INDICATOR AR32
RUDDER ANGLE INDICATOR AR33
RUDDER ANGLE INDICATOR AR34
MAGNETIC SENSOR FGX60

Directions to refer to:

- IEC 945 / 94
- IEC 945 – CISPR 16
- IEC 945 – II Ed. A.6.1, A.6.3, A.5.2
- IEC 801 – 3I, 801 – 2
- ISO/R 694

The present declaration of conformity is drawn up according to the CEI 110 – 24 directive “A guide to the application of law decree concerning electromagnetic compatibility (EMC)”.

Viareggio, April 18th, 2005.

Navicontrol s.r.l.
The President
Gambini Silvano

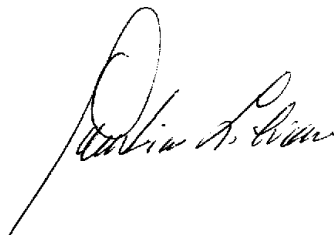

GEONAV
AP 201
AUTOPILOT

USER'S MANUAL

IMPORTANT WARNINGS

Seafaring experience is made exclusively at sea and not on land. So when you go out at sea, please do remember to take this manual with you and you will quickly learn to use the autopilot in the simplest and most logical way: actually using it.

To ensure your own and your passenger's safety, we recommend do not exploit your autopilot on occasions such as:

1. while maneuvering in particular shallow waters or over dangerous seabeds
2. while entering or exiting harbour, mooring and setting sail
3. in heavy traffic areas, near to breakwaters, canals and any kind of obstacle
4. in poor visibility
5. when in areas where use of autopilot is prohibited by law.

While your autopilot is operative on **AUTO**, **NAV** or **WIND**, be sure you do not abandon deck.

Check the course and the position of the vessel at regular intervals.

While learning, make sure you practice in open sea, far from shallow water, vessels or other obstacles.

Always switch to **STANDY** mode and reduce speed in sufficient time to avoid hazardous situations.

PRELIMINARY OPERATIONS AND START OF NAVIGATION.

Starting

Switch on the control panel and wait until the autopilot has performed the autodiagnostic test and visualizes the software identification codes.

At this stage, the system is in STANDBY so ready to be set.

Warning:

The first time that you use the autopilot, verify that the bearing of the compass shown by the display corresponds to the value determined by the vessel compass. In case of significant differences call a technician for a proper setting.

Furthermore, it is normal that in a system provided with the analogue rudder angle indicators, the values shown by the Control Unit may slightly differ from the one visualized by the instrument itself.

Display and keyboard illumination

Press the ☀ (light bulb) key in order to adjust the level of backlight of the display and keyboard: the autopilot has a 8 level of brightness.

Setting of the operating parameters

Enter the menu of operating parameters (YAW, RUDD and T.RATE) by pressing the ☀ (light bulb) key for two seconds at least. In order to change the values, press and release the ☀ (light bulb) key until you see the name of the parameter, then select by pressing the arrow keys ◀ and ▶.

You exit the menu by pressing the ☀ (light bulb) key or after few seconds of keyboard inactivity.

YAW

In some other autopilots, it is also named SEA or WEATHER and indicates the width of the channel in which the vessel navigates. The higher the value is and the higher the slack is respect to the course to be followed.

RUDD

It is the main parameter and corresponds to the gain of the vessel. This value is higher in which need a great deal of rudder quantity and vice-versa.

If the set value is higher respect to the optimum condition, the maintaining of the course will be instable (the vessel corrects continuously by “snaking” around the selected course).

If the set value is lower, the vessel cannot enter the selected course in reasonable time.

T.RATE

This parameter, which corresponds to the turn rate expressed in degrees per second, restricts the quantity of rudder during the turns. The higher the value is and the faster the turns are.

Setting of the route and automatic navigation

The high versatility of the autopilot allows to set the desired course in a variety of modes depending on the different operating conditions.

To change the pre-set course, you have to press the arrow keys (◀ and ▶) remembering that:

- if you press and immediately release the arrow, you change 10 degrees at time
- if you hold pressed for more than 1 second, you change 1 degree at time.

Course setting by “bow targeting”

It just consists in orienting the vessel towards the desired target and instructing the autopilot to assume the current bearing as the route to be done:

- autopilot in **STANDBY**
- steady the vessel on the required heading by turning manually the wheel of the rudder
- position the rudder to the dynamic center and press **AUTO**

Wishing to change the selected course, even during the navigation, it will be sufficient to modify the shown value by pressing the arrow keys (◀ and ▶).

Setting of the course

Independently from the bow targeting, position the rudder to the dynamic center and press **AUTO**. By pressing the arrow keys, select any course and the autopilot will execute automatically the operation.

Tack change

Particularly indicated in sailing vessels, the tack change is the operation which allows the changing of tacks. This function can be carried out automatically only during the **AUTO** mode.

The tack change is activated by pressing and releasing simultaneously the keys ◀ and ▶ : if you press again, within 5 seconds, the direction arrow key, the autopilot will execute the course change which correspond to the opposite tack.

The tack change is always carried out by facing the direction of the wind.

Turn

The TURN function is activated only when the autopilot is in **AUTO** mode.

In automatic mode (**AUTO**) and by pressing the **AUTO** key for 2 seconds at least, it is possible to execute one of the following turns:

- U TURN (180° turn)
 - O TURN (360° turn)
 - 8 TURN (360° turn followed by another 360° turn in the opposite direction)
- The selection of the kind of turning is activated by pressing and releasing the ☀ (light bulb) key until the desired kind is shown. Within few seconds, the arrow key which corresponds to the starting direction must be pressed.
- In order to stop these specific turnings, you only need to press **STBY** or **AUTO** keys or by actioning the external tiller.
- All these turnings are controlled by the value of the TURN RATE parameter: the higher its value, the faster the turning will be.

U TURN

U-turn inversion: turn change of 180° from the present followed course. When the turn has been completed, the autopilot returns in AUTO mode.

O TURN

Circle: the vessel turns on circle until this function is interrupted.

8 TURN

Double circle: the vessel executes an “eight” figure (a complete circle in one direction, and another in the opposite) until this function is stopped.

Instrumental navigation with GPS

If provided with a GPS or a chart-plotter correctly installed and interfaced with the autopilot, it is possible to set a course on these equipments to be followed automatically with the autopilot.

In fact, you only need to insert one or more waypoints (see GPS or chart-plotter manuals) and to set the autopilot in **NAV** mode (by pressing together **AUTO** and ► key). From this moment, the autopilot will be controlled by the satellite instrument and it will execute automatically any possible selected course changes.

Obviously, in this kind of functioning, the course to be followed is controlled by the satellite instrument and so it can't be modified by the autopilot. For this reason, the arrow keys (◀ and ▶) are deactivated.

Navigation with wind direction sensor

If provided with a wind direction sensor, correctly installed and interfaced with the autopilot, it is possible to set a tack angle to be followed automatically.

In fact, you only need to select the **WIND** mode of the autopilot by pressing the keys **AUTO** and ◀ together).

From this moment, the autopilot will be controlled by the direction of the wind and it will follow any change of direction automatically.

By pressing the arrow key (◀ or ▶) corresponding to the right side, it is possible to carry out the tack change. For safety reasons, this function can be activated only by pressing twice the right direction within few seconds.

The tack change is carried out by facing always the direction of the wind.

Remote Portable Control RS32

The autopilot becomes moreover flexible and practical if equipped with the hand-held remote control.

This optional device, equipped with 8 meters of cable, enables a full mobility on the control deck without loosing the control of the navigation system.

By pressing the **DODGE** key, you can switch from the present operating mode (e.g. **AUTO**, **NAV**, etc.) to the **STANDBY** mode and vice-versa.

Press the two keys (P as port, S as starboard) in order to action immediately the rudder in a way which depends from the operating mode selected at that time on the autopilot:

- in **STANDBY** the rudder is moved directly and then it is left in this final position,
- in **AUTO**, **NAV** or **WIND** the rudder is moved but at the release of the key, the autopilot is newly in control and converges to the starting course.

The running operating mode of the autopilot is signaled by the led of the hand-held remote control:

- ON: **STANDBY**
- OFF: **AUTO / NAV / WIND**
- FLASHING: during the pressing of the two keys (**P** and **S** and the following seconds.

Remote Control RC34, RS34

It is similar to the RS32: it differs from it for the fact that is designed to be flush-mounted and the **P** and **S** key here are replaced by a joystick.

Since the RC34/RS34 is flush-mounted, in case of rough waters the tiller is usually easier to operate than the keys.

Signaled alarms

The autopilot is able to signal and manage within possible limits, any anomaly in the system. It signals every kind of alarms to the Captain by the control unit display.

Of course, in any kind of electrical alarms, causes must be verified by checking also electrical connections (short-circuits, interruptions, oxidations and uncorrected wirings).

Even if of instinctive understanding, in the final section of this manual there is an explanatory chart with possible remedies.

GEONAV
AP 201
AUTOPILOT

INSTALLATION MANUAL

INSTALLATION PROCEDURES

The autopilot is powerful and sophisticated but its reliability strictly depends on a scrupulous installation and a proper configuration, of all devices and optional accessories included.

For safety reasons, the best way is to section the power supply of the processor box (and so of the whole autopilot) with a switch installed in the electric panel of the vessel, only for this purpose.

VERY IMPORTANT: the AP 201 PB80 version works only with 12Vdc systems. If your vessel is 24Vdc, you need the PB250 or PB350 Processor Box.

Control Unit

This is the 'cockpit' of the autopilot, and is through this unit that who is in commands instructs the system about the operations that must be executed.

Install the Control Unit in a position, on the main deck, where it will be easily reached and controlled: carefully chose the proper location and orientation so that the display will be perfectly readable from the operating position.

If the Control Unit is installed making use of the provided bracket, the visual angle can be easily varied by the user himself when necessary.

If the Control Unit is flush-mounted in the board panel, special attention must be given to the placing angle in order to ensure a perfect reading of the display. Even if the display has the back-light, if badly oriented the reading of all information data will be difficult.

The Control Unit is splash-proof, but it is not supposed to operate UNDERWATER! Thus, if externally installed, take care to position it in a shielded area with its protective cover.

The Control Unit must be connected to the Processor Box in the **TB7 CONTROL UNIT1** connector.

Control Unit (as OPTIONAL remote control)

An optional extra Control Unit must be installed with the same cares adopted for the first one.

Even if it is named remote control, it is identical to the main Control Unit both physically and functionally.

The second Control Unit must be connected to the Processor Box in the **TB8 CONTROL UNIT2** connector.

Processor Box AP

It is the heart and the brain of the autopilot: in fact it contains the main calculator of the system.

Install it far from direct heating, continuous vibrations and shocks; places like engine-room, bilge area or other similar locations must be avoided.

If the vessel is provided with a reversing electro-hydraulic actuator, it is necessary to position the Processor Box in an airy room. In fact, according to the actioning and the power required by the actuator, it is normal that the Processor Box overheats considerably (up to 50-60 Celsius degree).

We also recommended to install it in a place easy to be reached in order to allow the future installation of optional devices.

In order to avoid interference on radios, we suggest positioning of the processor box far from VHF aerials (few meters are sufficient).

Fluxgate Compass FGX90/3, FGX90N

As you can easily understand, it is another key device of the autopilot.

It is based on the electronic compass bearing that the autopilot keeps the vessel on the planned course, applying any needed correction, bringing you to the expected destination. An improper installation of this device will negatively affect the performances of the whole navigation system.

The compass fluxgate FGX90 can be used with wood, fiberglass and aluminum vessels. We suggest you to use the pick-up coils FGX60 for all the iron or steel vessels provided with a planar magnetic compass, externally gimbaled, correctly functioning and compensated.

As it is a magnetic compass, the first care will be the choice of location. It differ from the other electronic devices because it must be placed far from iron masses, magnetic fields and any device originating magnetic noises. The minimum distance to be taken from these possible interference is proportional to the intensity of noise and must be found at any time by way of experiment (e.g. by using a magnetic compass).

The magnetic fluxgate compass FGX90/3 must be connected to the Processor Box, **TB4 COMPASS** connector.

Rudder Angle Transducer FB30, FB31

This is another key element of the autopilot. In fact it is mechanically linked to the section of the rudder, and it informs the system on its real position.

It is fundamental that it is installed on a firm, rigid support respecting precisely the suggest mounting scheme.

Any slack both on the coupling bar and the rudder sector must be eliminated or this will falsify the measured rudder angle and the whole system will become inaccurate and critical.

The excursion time of the rudder from hardover to hardover must be not less than 12 seconds or more than 18 seconds, otherwise the system will be instable.

This transducer must be linked to the Processor Box, **TB5 FEEDBACK** connector.

Electrohydraulic Unit

For a correct use of the autopilot and in order to obtain the best performance, we suggest you to use hydraulic units suitable to the vessel steering system.

The flow-rate is the most important parameter when you choose a pump: it must be calculated to obtain a hardover to hardover time of about 12 seconds ($\pm 10/15\%$).

This is the formula to be used:

$$\text{FLOW-RATE(litres/min.)} = \text{RAM-VOLUME(litres)} \times 5$$

$$\text{FLOW-RATE(cc./min.)} = \text{RAM-VOLUME(cc.)} \times 5$$

When you use Rxx or CRxx Navicontrol pumps, you don't need any calculation: you must choose the pump with the nearest value to the ram volume (ie: RAM = 100cc. → PUMP = R100 or CR100).

The CR pumps (constant running) can be installed on every kind of boat and are mandatory for heavy or working vessels.

The R pumps (reversing) can be installed only on small pleasure vessels and, in any case, no more than 15mt. (50 feet) length over all.

The electronics and the software provided with the autopilot are suitable to drive the most popular 2 types of rudder actioning:

Constant running (CR model with solenoid valves)

Software: no setting (it is the default configuration).

Wirings:

- SOLENOIDS: **TB11** connector, Processor Box.
- MOTOR: **CR. MOTOR** faston connectors, Processor Box.
- Possible CLUTCH: **TB11** connector, Processor Box.

Reversing (R model)

Software: change the value of the function **HYDR UNIT** (installation menu') with the value **REV1**.
Use the values **REV2** or **REV3** respectively with fast or very fast power units.

Wirings:

- REVERSING MOTOR: **R. MOTOR** faston connector, Processor Box.
- Possible CLUTCH: **TB11** connector, Processor Box.

PRELIMINARY TEST.

After the installation of all mechanical and electrical components of the autopilot, a first testing must be executed when still anchored or at the shipyard.

In order to obtain the best performance of the system, it is necessary to carry out at least a trial at sea.

The first testing to be executed refers to the correct installation of the sensors and must be carried out in the following sequence:

Rudder Feedback FB30, FB31

When the autopilot is in STANDBY mode, the graphic bar of the Control Unit shows the reading of the sensor. By turning manually the wheel of the rudder, verify that the angle shown is identical to the real position of the rudder.

If the indication of the rudder direction is opposite to the real one, switch off the autopilot and invert the wiring connections which are linked to **TB5 FEEDBACK** connector, pin 3 and pin 4.

Rudder Indicator AR32, AR33, AR34

When the autopilot is in STANDBY mode, verify that the analogue rudder indicator indicates exactly what is shown on the graphic bar of the Control Unit: in case the analogue indicator is inverted, you must invert the two wires which are linked to the Processor Box, pin 1 and pin 2 (**TB9 / TB10** connector).

Fluxgate Compass FGX90/3, FGX90N

When the autopilot is in STANDBY mode, the large display shows the reading of the electronic compass. Verify that there is no interference and the value indicated by the main compass is not very different. In case of significant difference, try to change the position of compass (if interfered) or by turning it on its axle until the difference is cancelled.

Electrohydraulic Unit

If it is possible, when the vessel is still at the shipyard or still anchored, position manually the rudder to the center. In AUTO mode, execute a course change of 10 / 20 degree and check that the rudder moves in the correct direction and in a intermediate position (the movement must be proportioned to the change).

In case the rudder moves in the opposite direction, invert the right and left solenoids (power unit with solenoids) or invert the wires of the motor (reversing power unit).

GPS and/or Chart-Plotter

In these instruments, select the output data to NMEA0183 standard (usually is the default configuration and no manual operation is required).

Insert a course on these instruments and verify that the autopilot receives correctly the bearing from them by placing it on NAV mode.

Wind Direction Sensor

Verify that the sensor is connected to the TB1 connector of the Processor Box, NAV2 input.

Select the output data to NMEA0183 standard (usually is the default configuration and no manual operation is required) and verify that the autopilot receives the correct bearing of the wind by pressing together **AUTO** and ◀ keys.

Automatic compensation of the compass FGX90/3, FGX90N

The fluxgate compass FGX90 is already compensated at the factory and if correctly installed on wooden, fiber glass or aluminum crafts, it does not require further compensation.

If it is not possible to position it in an ideal location, at this stage is useful the compensation aboard.

This autopilot allows the automatic compensation without the help of a technician.

In fact, you only need to go out at calm sea with the vessel avoiding crowded areas and to carry out the following operations:

1. Switch on the autopilot in STANDBY mode and make the vessel turning slowly on circle. In order to obtain a good compensation, the maximum angular speed must not exceed the 6 degree per second (corresponding to a complete revolution taking 1 minute at least).
2. Press the **STBY** key for at least 5 seconds and wait until the display visualizes "FLUXG AUTO". At this stage, release the **STBY** key.
3. Wait until the vessel has carried out a complete revolution checking always that the angular speed is steady and under the maximum limit. If the vessel, during this turn should rock significantly (for instance a big wave, the passage of another vessel), repeat again the procedure.
4. Keep on turning in circle until the autopilot will display the maximum amount of the interference and the result of the compensation: Good if succeeded, Bad if failed.
5. At this stage, the procedure is completed and you only need to press the **STBY** key in order to return to the normal functioning.

If the autocompensation failed (result = Bad), it means that the chosen location for the installation of the compass is too interfered and therefore the location must be changed.

Warning: the autocompensation procedure can be interrupted only by removing the power supply to the autopilot (or, of course, by ending the complete revolution of the vessel).

SOFTWARE INSTALLATION PROCEDURE

WARNING: the software installation procedure of the system is very delicate and implies a profound knowledge of its functioning. Thus, we advise you to avoid the changing of the values supplied with the default if you do not exactly know the effects.

In addition, we remind you that all parameters are pre-selected and are suitable to the majority of vessels.

In order to start the installation procedure and to change the setting of default, you must proceed in the following order:

1. Press the key **STBY**
2. Press the key ☀ (light bulb) for five seconds at least until 'INSTL' is visualized.
3. Release the key and press only the key ☀ (light bulb) until the required function is selected.
4. Modify the value by using the arrow keys ◀ and ▶.
5. When the settings are ended, press newly **STBY** to exit.

List of the functions:

Various Analog Compass Data

Reading of the intensity of the compass signal: it is useful in case the FGX60/3 (pick-up) is installed instead of the fluxgate compass FGX90. It is a reading and cannot be modified.

RUDDR LIMIT (Rudder Limitator)

Electronic limiting on the rudder actioning: sets the maximum rudder angle that the autopilot can reach.

F/B SLACK (Feedback Slack)

Slack on the rudder: sets the tolerance (dead-band) on the rudder positioning. It can be useful to increase it by very fast actionings or by relevant dragging.

F/B 0 POS (Feedback Zero position)

Zero position of the feedback: it allows to correct a possible variation of alignment of zero between the real position of the rudder and the zero position of the feedback. Even if it is possible to execute with this function, we advise you to zero mechanically by actioning the feedback (turning all the feedback).

F/B TYPE (Feedback Type)

Model of the connected feedback: FB3 (FB30 or FB31) – PTn (potentiometer)
– PTr (reverse potentiometer).

HYDR UNIT (Hydraulic Unit)

Model of electrohydraulic unit installed: SOL (with solenoids) – RV (reversing). RV can be equal to 1, 2 and 3 respectively with correct units, fast units and very fast units.

ENERG SAVE (Energy Saver)

It activates or deactivates the energy saving on the control of the electrohydraulic unit: it avoids the keeping of the motor running when it is not necessary. It is particularly useful in small sailing vessels. ON enables it, OFF disables it.

RUDDR ALR (Rudder Alarm)

Rudder Alarm function: OFF disables the signaling of the malfunction, ON enables it, SBY disengages the autopilot if the rudder has moved manually (override).

COMP TYPE (Compass Type)

Model of the connected magnetic compass: FG9 (FGX60/3, FGX90/3 or FGX90N) – SC2 (Smart Compass SC2N or SC2G).

COMP ALIGN (Compass Alignment)

Alignment of the compass: it allows to increase or decrease the reading of the electronic magnetic compass of a fixed quantity avoiding the physical turning of it.

COMP DAMP (Compass Damping)

Damping filter on the magnetic compass: the higher is the value and the more filtered the compass is.

INTEG TC (Integrator Time Constant)

Time constant of the main integrating control: avoid changing it (only for qualified technicians).

DERIV TC (Derivator Time Constant)

Time constant of the main derivating control: avoid changing it (only for qualified technicians).

NAV GAIN (Navigator Gain)

Gain of the Cross Track Error of the NAV control: avoid changing it (only for qualified technicians).

NAV2 FUNCT (Nav2 Function)

NAV2 input function: in the AP103 gold, this function is fixed at WND (wind).

COURS TIMER (Off-Course Timer)

Off-course timeout alarm: the timeout (in seconds) between an off-course (set course and heading differ of 20 degrees at least) and the start of the OFF-COURSE alarm. OFF disables it.

INFO DISPL (Info Display)

Setting of the info-display: the AP 201 has not this feature and this function is disabled (OFF).

RC FUNCT (Remote Control Function)

Action of the remote controls (RS32, RC34, RS34 and ART35). The values are:

[STD] : when you are in AUTO, the direction keys on the remote control make a momentary change of course. When you release, the autopilot comes back to the previous course.

[5°] - [10°] or [20°] : when you are in AUTO, the direction keys on the remote controls change permanently the course for the specified amount of degrees (5, 10 or 20 degrees) each time pressed.

TECHNICAL SPECIFICATION

Operating specifications.

Supply voltage	12 ÷ 32Vdc (PB80 = 12Vdc only)
Power consumption (electronic parts only)	1A max.
Maximum solenoids load	4A (each one)
Maximum hydraulic unit load ("CR" type)	25A @ 12V, 20A @ 24V
Maximum hydraulic unit load ("R" type)	80 ÷ 350W, according to the model
Operating temperature	-5 ÷ +55°C
Control unit display type	transflective LCD, wide viewing angle

Inputs / outputs.

- 2x NMEA0183 opto-coupled inputs.
- 1x digital opto-coupled input, meets NMEA0183 specifications.
- 1x feedback input (LVDT type).
- 1x feedback input (resistive type).
- 1x analogue compass input (sin/cos type).
- 2x control unit connector (bi-directional).
- 2x analogue rudder indicator outputs.
- 3x solenoid outputs (left, right, clutch).
- 1x hydraulic power unit output, constant running model.
- 1x hydraulic power unit output, reversing model.

ALARMS

SIGNALING	MEANING	POSSIBLE CAUSES	REMEDY
NO COMP	Lack of compass signal.	Relevant magnetic interference nearby the compass sensor or failure of the sensor.	Remove the interference. Call the technician.
TILLR FAILR	Failure on the remote control (tiller or hand-held).	Remote control keys failure. Water on the hand-held remote control.	If it is possible, disconnect the remote control. Call the technician.
OFF COURS	Off course.	The vessel does not enter the course in reasonable time. Possible interfered compass.	Remove the interference.
NO FBACK	Lack of signal of the feedback sensor.	The feedback is not working.	Call the technician.
NO RUDDR	The rudder does not follow the given orders.	Possible failure on the electrohydraulic unit. Presence of air bubbles in the hydraulic circuit. Excessive mechanical slack between the rudder and the feedback.	Call the technician. The discharge of the hydraulic circuit must be carried out. Tighten the mechanical connection between the feedback and the rudder sector.
NO GPS INPUT	Lack of GPS signal.	Possible failure on the GPS. The GPS has not yet calculated the position. The data transmission to the autopilot has been deactivated.	Refer to the GPS manual.
NO PLT INPUT	Lack of PLOTTER signal.	The plotter has not yet sent the course to the autopilot. The data transmission to the autopilot has been deactivated.	Refer to the PLOTTER manual.
NO WND INPUT	Lack of WIND signal.	Possible failure on the wind vane. The data transmission to the autopilot has been deactivated.	Refer to the wind vane manual.
OVERHEAT	Overheat of the electronic on the autopilot Processor Box.	Electrohydraulic unit unsuitable for the processor box electronic. The location where the processor box has been fitted is insufficiently ventilated.	Ventilate the area where the processor box is installed. Call the technician.
LOW BATT	Low battery.	The battery is low and does not supply sufficient energy for the running of the autopilot.	Check the battery status. Turn on the battery charger.

AUTOPILOT SYSTEM

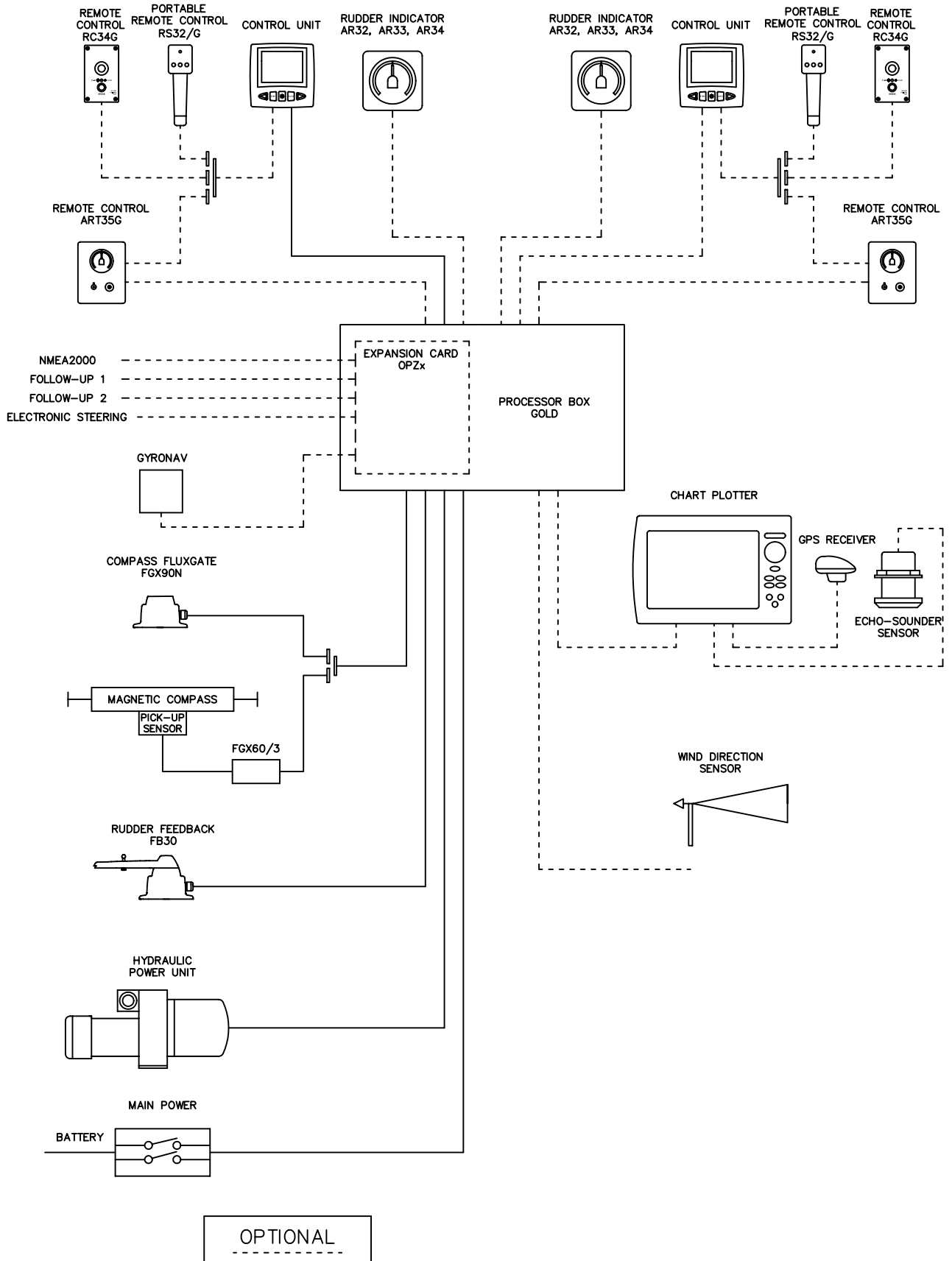

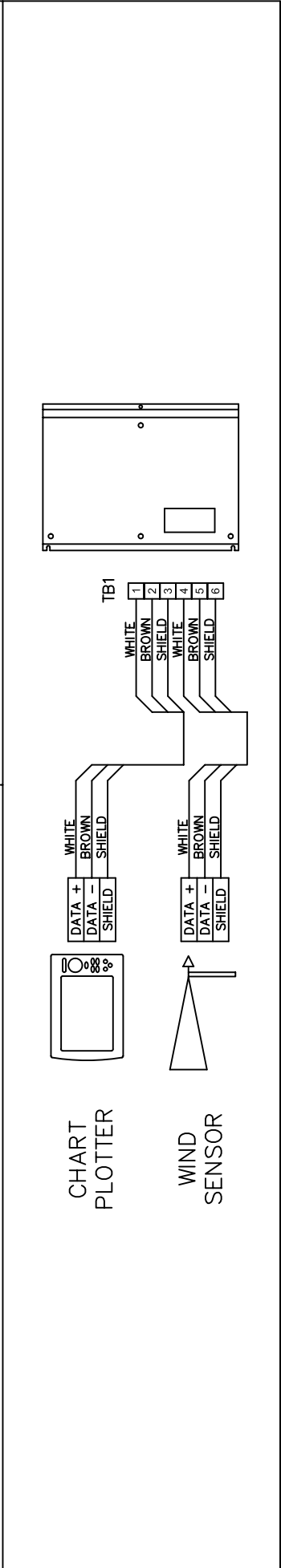
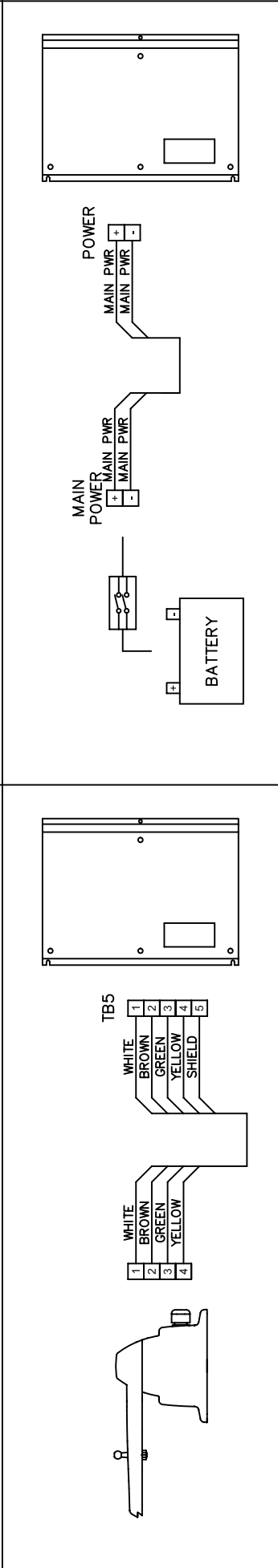
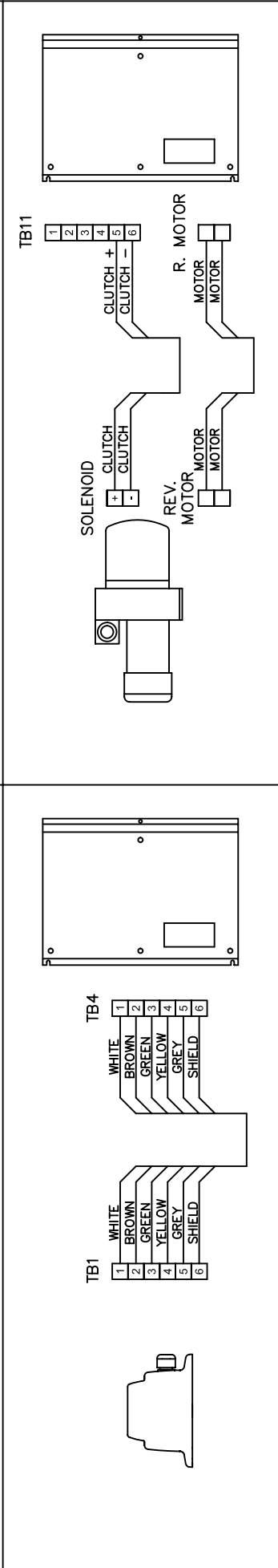
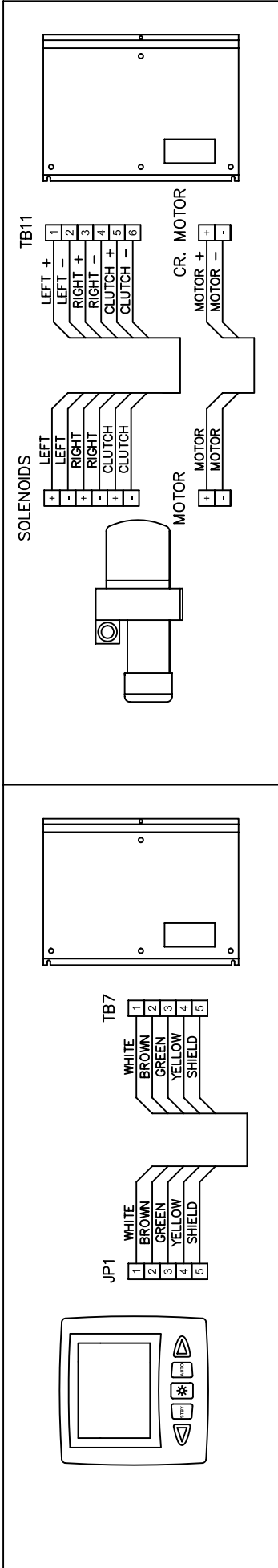

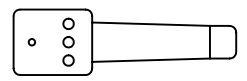
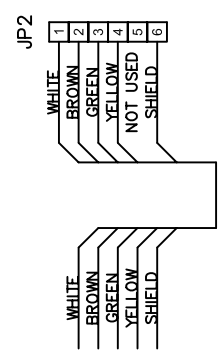
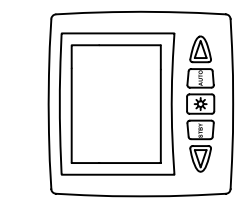
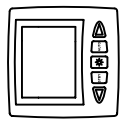
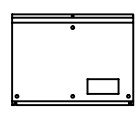
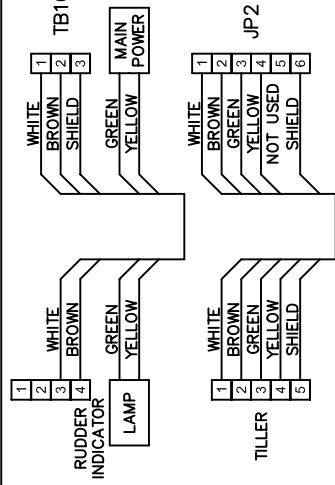
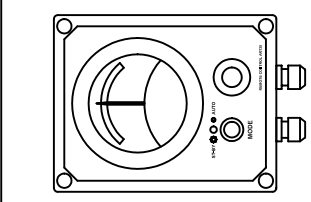
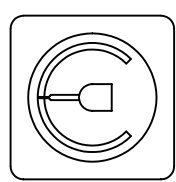
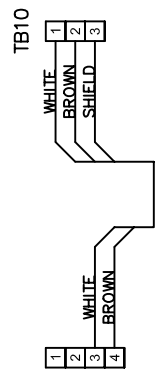
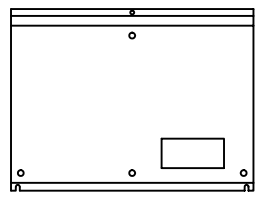
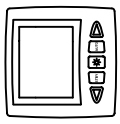
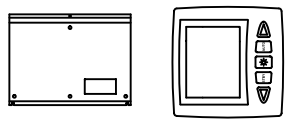
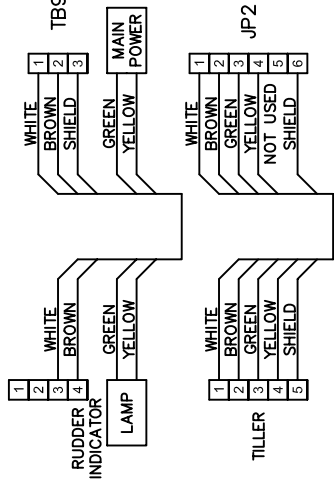
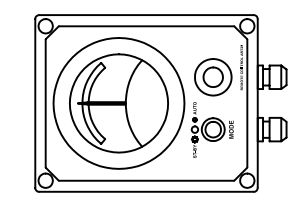
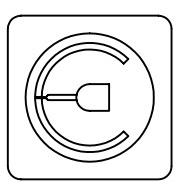
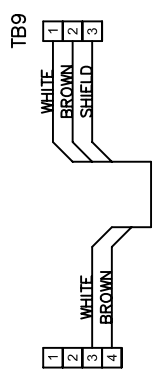
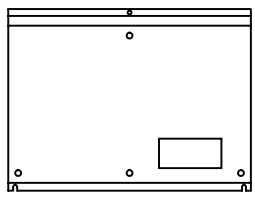
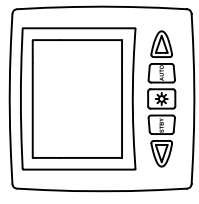
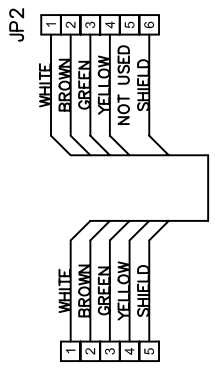
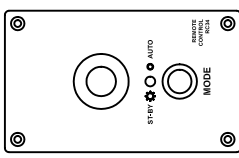
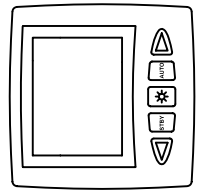
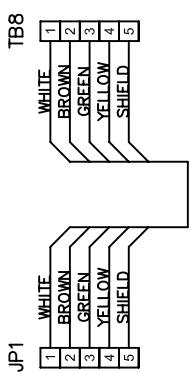
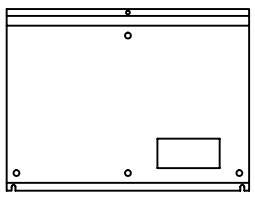

AP 201 CONTROL UNIT DIMENSIONS

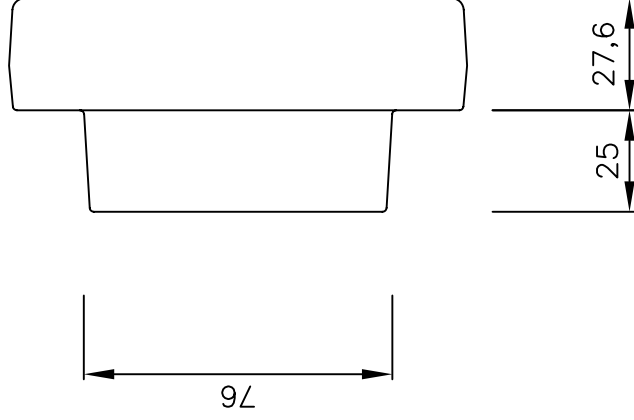
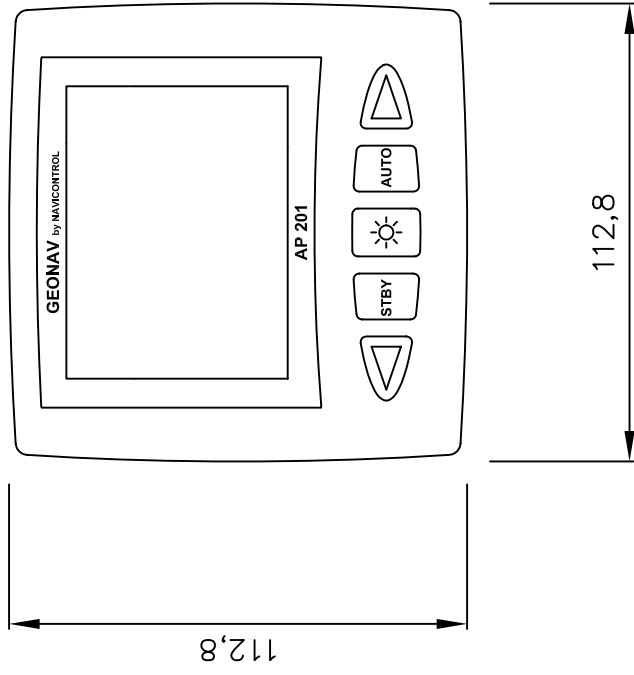

RUDDER FEEDBACK FB30 mechanical installing / installazione meccanica

Measures A and B are MANDATORY for the correct performance of the autopilot.

Il rispetto delle misure A e B è OBBLIGATORIO per il corretto funzionamento dell' autopilota.

